

Twidley™

THE PERSONAL / OFFICE RECEPTIONIST™

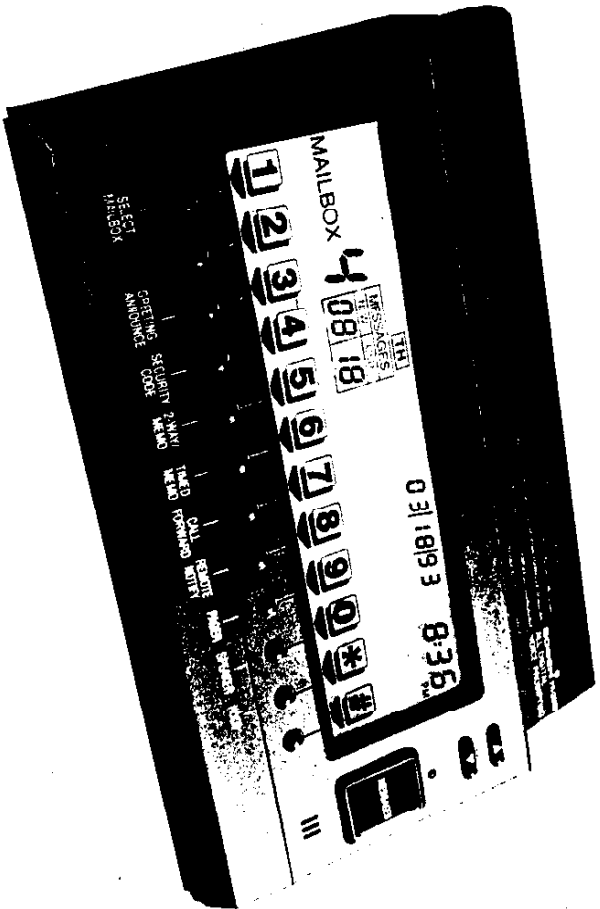

Installation & Operating Instructions
Models: FR-1000 & FR-2000
All Digital Voice Prompting

Before you install Friday, please do the following:

- 1. Staple your sales receipt to the inside front cover of this manual.**
- 2. Fill out and send in the Warranty Card.**

In the event of a problem with this unit, please call

9311 Part No. 54-5951-04
Printed In U.S.A.

Contents

Before You Begin	
1. Important Safety Information	pg. 5
Introduction	
2. Introducing Friday	pg. 7
Getting Started	
3. Parts Checklist	pg. 7
Getting to Know Friday	
4.1. Location of Front Panel Controls	pg. 8
4.2. Location of Rear Panel Controls and Jacks	pg. 9
4.3. Location of Base Panel Components	pg. 9
Installation	
5. Install Memory Expansion Module	pg. 10
6. Install Battery	pg. 11
7. Remove Protective Cover	pg. 11
8. Connect Telephone Line Cords	pg. 12
8.1. For a one-line unit (Model FR-1000)	pg. 12
8.2. For a two-line unit (Model FR-2000)	pg. 13
8.2.1. To attach one 2-line telephone	pg. 13
8.2.2. To attach two 1-line telephones	pg. 14
9. Other Connections	pg. 15
9.1. Connecting a Fax Machine or PC	pg. 15
9.2. Connecting Music-On-Hold	pg. 15
10. Mounting Friday on the Wall	pg. 16
11. Connecting the AC Adapter	pg. 18
Setting Up Friday	
12. Initial Settings	pg. 19
12.1. Set the Number of Rings Desired	pg. 20
12.2. Set the Time and Date	pg. 21
12.3. Set the Speaker Volume	pg. 22
12.4. Check the CPC Switch	pg. 22
13. Main Greeting	pg. 23
13.1. To Play Main Greeting	pg. 25
13.2. To Attach a Message	pg. 25
13.3. To Record Main Greeting	pg. 26
14. Setting Up a Mailbox	pg. 26
14.1. To Activate a Mailbox	pg. 26
14.2. To Deactivate a Mailbox	pg. 27

Contents

Working With Friday

15. Select Mailbox	pg. 28
16. Mailbox Greeting/Announcement	pg. 29
17. Security Codes	pg. 30
18. How to Leave Messages for Others	pg. 32
19. Timed Memo	pg. 32

Advanced Features

20. Call Forward	pg. 33
21. Pager Notification	pg. 34
22. Remote Urgent Message Notification	pg. 35
23. Call Block	pg. 36
24. Maximum Message Time	pg. 36
25. Announce Caller	pg. 37
26. Do Not Disturb	pg. 38
27. Memory Check	pg. 38
28. Retrieving Your Messages	pg. 38

28.1. To Retrieve Messages Locally	pg. 39
28.2. To Retrieve Messages Remotely	pg. 39
29. Programming Friday Remotely	pg. 41
30. Friday From the Callers Perspective	pg. 42
31. Turning Friday On or Off	pg. 43
32. Set Distinct Ring	pg. 44
33. Ringing to the Data Port	pg. 45

Options While On The Phone

34. Speaker Feature	pg. 45
35. Hold Operation	pg. 46
36. How to Record a Phone Conversation	pg. 47
37. How to Return Caller to the Main Greeting	pg. 47

In Case Of Difficulty

Quick Tips & Clever Tricks

Warranty

FCC Notice

Before You Begin

1. Important Safety Information

Before using this unit, please read and follow all safety and operating instructions carefully. The unit has been designed and manufactured to assure personal safety. However, improper use can result in injury, electric shock, or fire hazard. The safeguards incorporated in this unit will protect you if you observe the following procedures for installation, use and servicing. This unit does not contain any parts that can be repaired by the user.

- Never install telephone wiring during a lightning storm.
- Never install telephone jacks in wet locations unless the jack is specifically designed for wet locations.
- Never touch uninsulated telephone wires or terminals unless the telephone line has been disconnected at the network interface.
- Use caution when installing or modifying telephone lines.
- To reduce the risk of electric shock, do not disassemble this product. Opening or removing covers may expose you to dangerous voltages or other risks.
- Do not overload wall outlets and extension cords as this can result in the risk of fire or electric shock.
- Do not place this product on an unstable cart, stand, or table. Serious damage may result if the unit falls.
- Do not use this unit near water – for example, near a bath tub or swimming pool. If the product comes in contact with any liquids, unplug the unit from the wall and contact qualified service personnel.
- Do not use liquid or aerosol cleaners.
- Instead use only a slightly damp, soft cloth for cleaning.
- Do not subject this product to excessive heat (sunlight and radiators), smoke, dust, mechanical vibration, or shock. This includes not placing heavy objects on top of this unit. Instead see the section on wall-mounting. Never rest objects on top of the LCD display, as this may cause cracks.
- Install this product in a protected location where no one can step on or trip over power and line cords. Do not place objects on the cords that may cause damage or abrasion. If the power supply cords or plug is damaged or frayed, unplug the unit from the wall and contact qualified service personnel.
- This product should be operated only from the type of power source indicated on the marking label. If you are not sure of the type of power supply to your home, consult your local power company.
- Do not use attachments not recommended by the product manufacturer as they may cause hazards.
- Please retain this booklet for future reference.

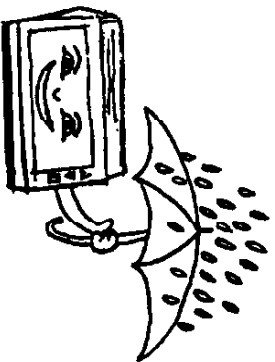

Introduction

2. Introducing Friday

Congratulations on the purchase of your new Friday™ Personal Office Receptionist.™ This unit has been designed to exacting Bogen standards for convenient and reliable service.

Friday is an advanced digital answering system that offers many features not found in standard answering devices. Functioning as a complete message management system, Friday offers multiple mailboxes and the ability to selectively save and delete messages, forward calls to any location, share telephone lines with a fax machine or PC, screen your calls, and professionally manage your telephone activity.



■ **Voice Mail** — The system comes equipped with a total of eight voice mailboxes — four personal voice mailboxes, three announcement-only boxes, and one mailbox dedicated to a fax machine or PC. Friday has 18 minutes of digital memory and can be upgraded to 36 minutes with a memory expansion module you easily plug into the back of the unit. Expansion modules are available at your Friday retailer.

■ **Electronic Receptionist** — Friday is not simply an answering machine. The system serves as an electronic receptionist that manages calls rather than just taking



messages. Friday answers the telephone and, at your request, can provide caller announce, music-on-hold, route calls automatically to specific voice mailboxes and even remind you of pending appointments. Each personal voice mailbox can forward calls instantly to any remote location, allowing you to remain constantly in touch anywhere — and at any time — with the office and with customers.

■ **Data Transmission** — Friday can detect and route data transmission to a fax machine or PC automatically. The built in voice-data switch lets all your office communications equipment coexist on the same lines as your telephone.

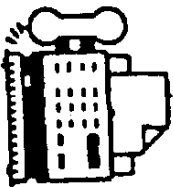

Friday also offers:

- **Speaker Monitor**
- **Caller Announce Screening**
- **Do Not Disturb**
- **Conversation Recording**
- **Full Battery Backup** — keeps memory intact during power outages
- **Music-On-Hold Input** — for a radio or CD player
- **Low Memory/Battery Indicator** — an indicator turns on when the memory or battery is low

Friday User's Guide

Getting Started

This manual explains in simple steps how to install and use your new Friday. For your convenience, we have included a Quick Reference Guide. Since the Friday unit comes equipped with audio voice prompting, the system itself easily guides you through the steps of operation. If you have any questions, call Bogen Communications, Inc. at 1-800-456-5513. We'll be happy to help.

3. Parts Checklist

Save your sales receipt in case you ever need warranty service (staple it to the inside front cover of this manual). Also, check to make sure that you have all of the following accessories. Please keep the packing materials in case you need to send the unit in for service. You should have each of the following:

■ Friday unit

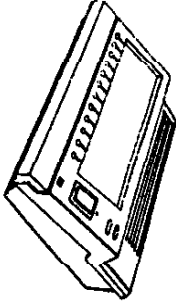

■ Memory Expansion Module
(Only included in 36 minute units)



■ Line cords — 2 cords for the two-line unit (Model FR-2000), or 1 cord for the one-line unit (Model FR-1000)



Friday User's Guide



■ User's Guide, Quick Reference Card, Warranty Card

■ AC adaptor (power supply)



■ 9-volt battery



■ Wall Mount Bracket

You will also need a wall- or floor-mounted modular telephone jack and an electrical outlet (120VAC/60Hz) near the place that you have chosen to install Friday. If you have an older, plug-type jack, you will need to buy a modular jack adapter.

Electrical Wall Outlet



Modular Telephone Line Jacks

Wall



Floor

Getting To Know Friday

4.1. Location of Front Panel Controls

1. Built-in Speaker.
2. LCD Display Panel.
3. Function Selection Pushbuttons. Used to select/activate/define functions.
4. Function Selection Panel (Flips down to reveal second function for pushbuttons).
5. Microphone.
6. Messages Pushbutton. Used to retrieve messages from mailboxes.
7. Message LED. Lights when you have a new message in a mailbox.
8. Volume Pushbuttons. Used to adjust the speaker volume.

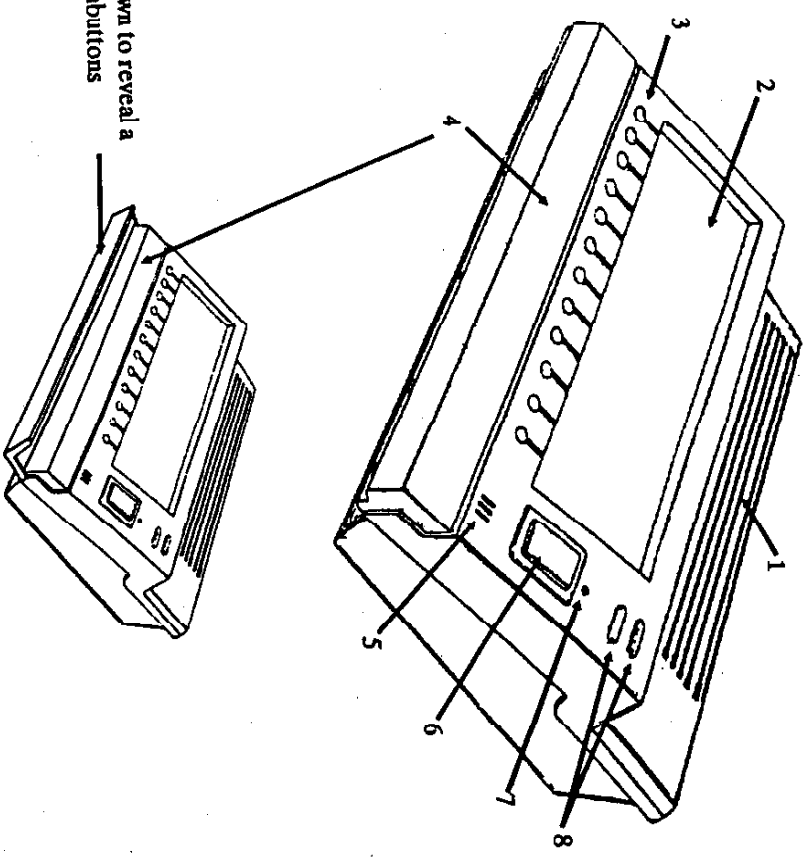

The Function Selection Panel flips down to reveal a second function for the Function Pushbuttons

Getting To Know Friday

4.2. Location of Rear Panel Controls and Jacks

Model FR-1000 1-Line Unit

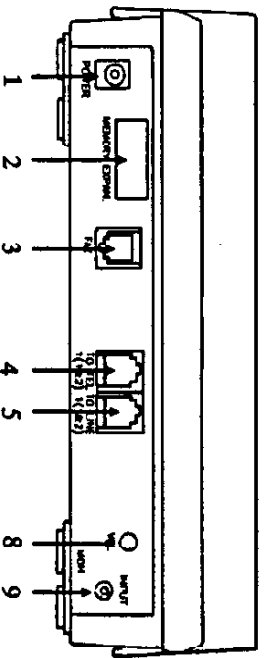

Model FR-2000 2-Line Unit

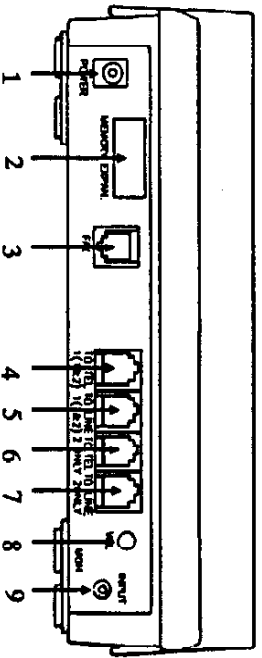

1. Power Input
2. Memory Expansion Module Cover
3. Fax/PC modem modular jack
4. TO TEL 1 (1 & 2) modular jack
5. TO LINE 1 (1 & 2) modular jack
6. TO TEL 2 ONLY modular jack (Model FR-2000 only)
7. TO LINE 2 ONLY modular jack (Model FR-2000 only)
8. Music-On-Hold Volume Control
9. Music-On-Hold Input Mini-Jack

4.3. Location of Base Panel Components

Battery Compartment

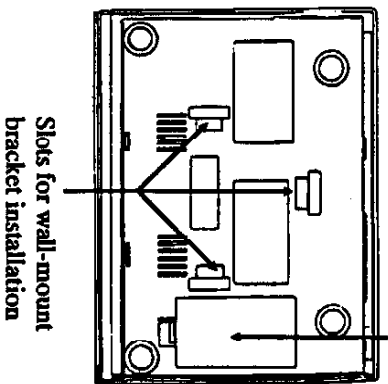

Installation

5. Install Memory Expansion Module

The memory expansion module doubles Friday's total memory capacity to 36 minutes from 18 minutes. If you have purchased the 36 minute unit, you will find the memory module in the box. If you have the 18 minute unit, the expansion module is available from the location where you purchased Friday.

WARNING: The memory expansion module must be installed before you install the battery and before you connect Friday to the power supply. To install the module after Friday has been programmed, you must remove the power supply cord and the battery before proceeding. Removal of power and battery clears Friday of all setup information and returns the unit to the original factory default configuration.

- Avoid touching the gold connectors
 - Remove Memory Expansion Cover
- Turn to the back panel of Friday and locate the rectangular cover labelled MEMORY EXPANSION. Use a small screwdriver to gently pry up and lift off the cover.

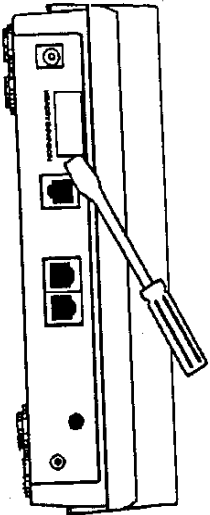

10

- Insert Expansion Module

Position the module with the gold connector end facing into the opening of the unit and slotted side facing downward. GENTLY push the module into the opening until it fits snugly in place and won't go in any further.

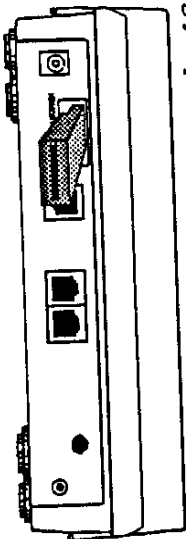

To ensure proper contact, insert the memory module by pushing the corner as shown.

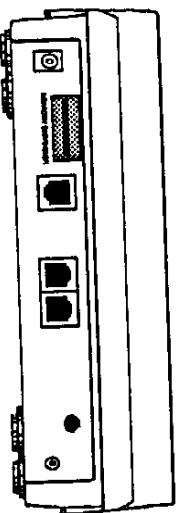
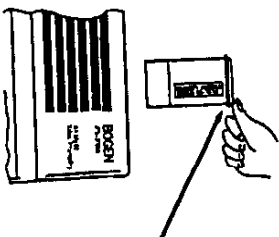

Once installed, the Friday will have 36 minutes of digital memory.

Friday User's Guide

6. Install Battery

The Friday includes a battery backup system to protect the memory during a power interruption.



- Turn the unit over, and remove the cover of the battery compartment. See the drawing below for the location of the battery compartment.
- Install the 9 volt battery (included) so that the terminals on the battery snap into the corresponding terminals on the battery connector.

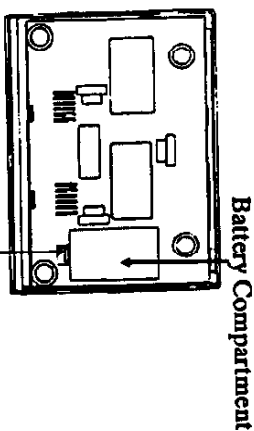

- Place the battery in the compartment and replace the cover.

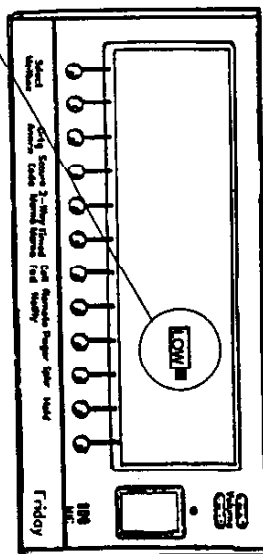

When this symbol is on, it's time to replace the battery.

Note: You should change the battery every six months (or when the LOW symbol appears) to avoid losing programmed messages, security codes and clock setting in the event of a power interruption.

When you change the battery, keep Friday plugged into the wall outlet. This will prevent erasing any of your greeting messages or configuration programming.

7. Remove Protective Cover

We put a protective cover on Friday's display panel to protect it during factory handling and packaging. The cover should be removed before use.

Installation

8. Connect Telephone Line Cords

Important Safety Information

- Never install telephone wiring during a lightning storm.
- Never install telephone jacks in wet locations unless the jack is specifically designed for wet locations.
- Never touch uninsulated telephone wires or terminals unless the telephone line has been disconnected at the network interface.
- Use caution when installing or modifying telephone lines.

If you are going to place your Friday unit on a desk or table top, proceed with the following instructions to connect your telephone line cord(s). If you are going to mount your Friday unit on a wall, read the instructions on pages 16 and 17 and then return to this page.



8.1. For A One-Line Unit (Model FR-1000)

- Connect Friday to the outside line
- Take a line cord and plug one end into the jack on Friday marked TO LINE 1 (1&2). Plug the other end into the modular jack.

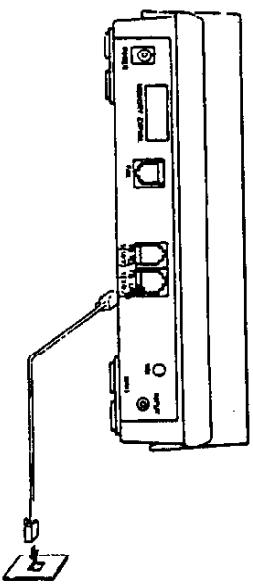

- Connect Friday to the telephone
- Take a line cord and plug one end into the jack on Friday marked TO TEL. 1 (1&2). Plug the other end into the jack on the telephone.

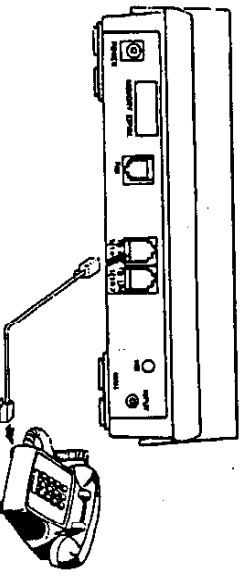

Friday User's Guide

Installation

8.2 For a Two-Line Unit (Model FR-2000)

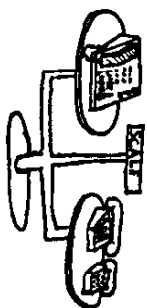

You have two options when connecting Friday to the phone. You may either attach a 2-line telephone unit, or you may attach two single-line telephones, each with its own phone number. Follow the instructions below to connect one 2-line telephone. Follow the instructions on the next page to connect two single-line telephones.

8.2.1 To attach one 2-line telephone

- Connect Friday to the telephone.**
Take a line cord and plug one end into the jack on the telephone. Plug the other end into the jack on Friday marked **TO TEL 1(1&2)**.

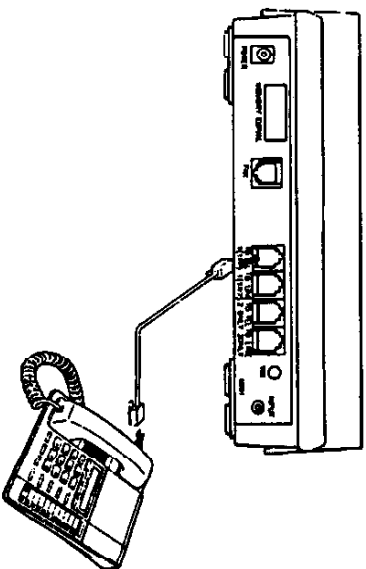

- Connect Friday to the outside line(s).**
If your 2-line phone has 1 line cord, plug one end into the jack on Friday marked **TO LINE 1(1&2)**. Plug the other end into the modular jack.

If you have 2 lines, plug the second line into the jack on Friday marked **TO LINE 2 ONLY**.

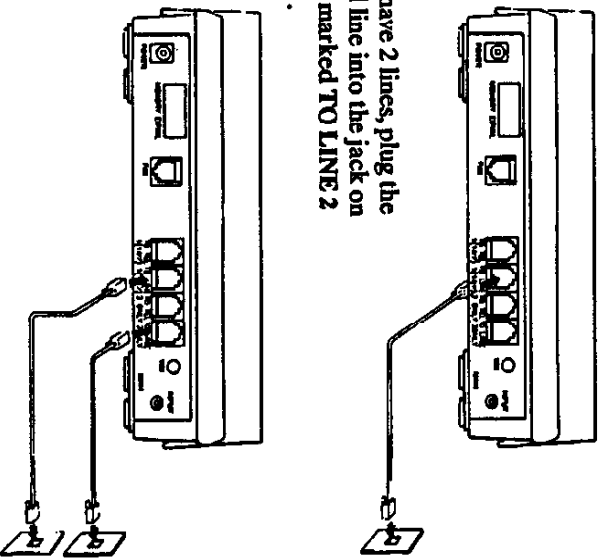

Installation

8.2.2. To attach two 1-line telephones

Two separate telephones may be attached to the 2-line Friday as long as each of the phones has its own phone number.

- Connect two telephones

Take a line cord and plug one end into the first telephone. Plug the other end of the cord into the jack on Friday marked **TO TEL 1 (1&2)**.

Take a line cord and plug one end into the second telephone. Plug the other end of the cord into the jack on Friday marked **TO TEL 2 ONLY**.

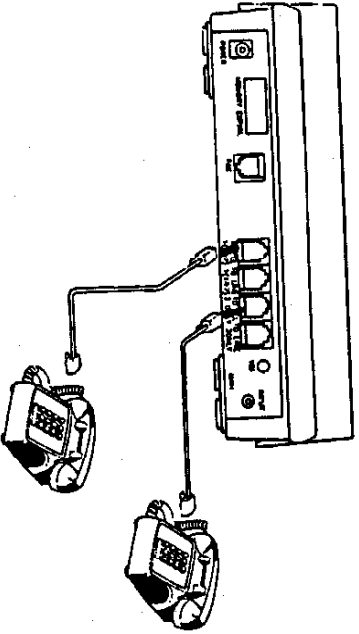

- Connect Friday to the outside line(s).

If both lines end in one modular jack, take a line cord and plug one end into the jack on Friday marked **TO LINE 1 (1&2)**. Plug the other end of the cord into the modular jack.

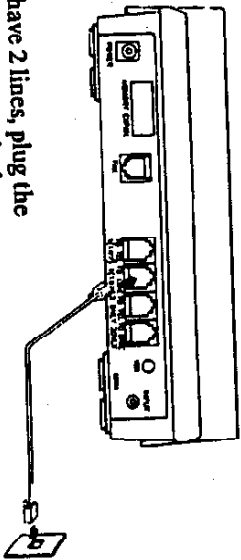

If you have 2 lines, plug the second line into the jack on Friday marked **TO LINE 2 ONLY**.

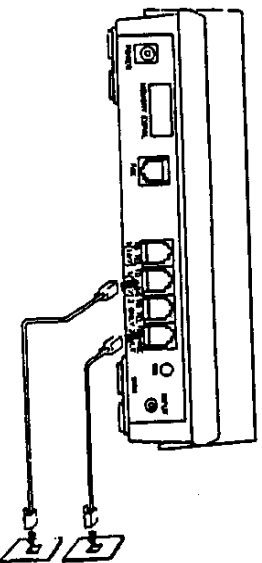

Installation

9. Other Connections

The following optional connections apply for 1-line and 2-line Friday units.

9.1. Connecting a Fax Machine or PC

Friday lets you connect either a fax or a PC with a modem so that you can share voice and data over the same phone line(s). Through Friday, you can have phone conversations, and both send and receive faxes or remotely access information in your PC. For the two-line unit, the data switch works on both lines.

- To install, first set your fax machine to answer in one ring. Then plug the line from your fax machine or PC modem into the jack on Friday marked FAX.

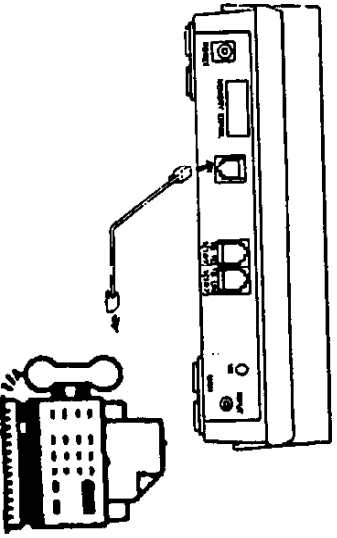

- Activate Mailbox 8 (see Section 14). Friday will then answer the call with a prompt to 'please press 0.' During this pause (10-sec in length), Friday will respond to the CNG tone from a fax machine and automatically route a fax call to your fax machine. Following the pause (or if the caller presses [0]), Friday will play your Main Greeting.
- When mailbox 8 is not activated, Friday immediately answers the call with the Main Greeting.
- To ensure that the sending fax machine does not time out during autofax transmission, you should program Friday to answer in three rings (see Section 12.1).

9.2. Connecting Music-On-Hold

A mini-jack on the rear panel of Friday marked MUSIC-ON-HOLD INPUT lets you plug in a music source, such as a CD player or walkman. Note that the music source must be left on in order for music to be played while the hold function is in use.



Next to the music jack is a knob marked VOL. Turning this knob clockwise increases the music-on-hold volume over the system. Turning it counterclockwise decreases the volume. Use a small screwdriver to turn the knob.

Note: To adjust the on-hold volume level, have someone call the unit and put the call on hold. They will then be able to hear the music and can help you adjust the volume to the desired loudness.

Installation

10. Mounting Friday on the Wall

When you want to mount Friday on the wall, choose a location close to the AC outlet. Ideally, Friday should be attached to a telephone line wall plate; however, if this is not practical, you can still mount Friday on the wall as long as the line cord is within reach of the telephone jack.

- Install Memory Expansion Module (if applicable). See page 10.
- Install battery. See page 11.
- Pass one end of the line cord through the opening in the bracket. Coil the cord so that it fits within the bracket. Take the other end of the line cord and lay it in the slot in the top of the bracket. (If the cord is too cumbersome to fit in the wall bracket, a small (6") cord can be purchased and used). Do the same with the second line cord if being used.
- Place Friday on the wall bracket by aligning the three prongs on the bracket with the three matching slots on Friday (see page 9). Gently squeeze in the two side panels of the wall mount and press down until the wall mount clicks into place.
- Attach the wall bracket to the telephone outlet's wall plate mounting studs and pull down until it is held securely.

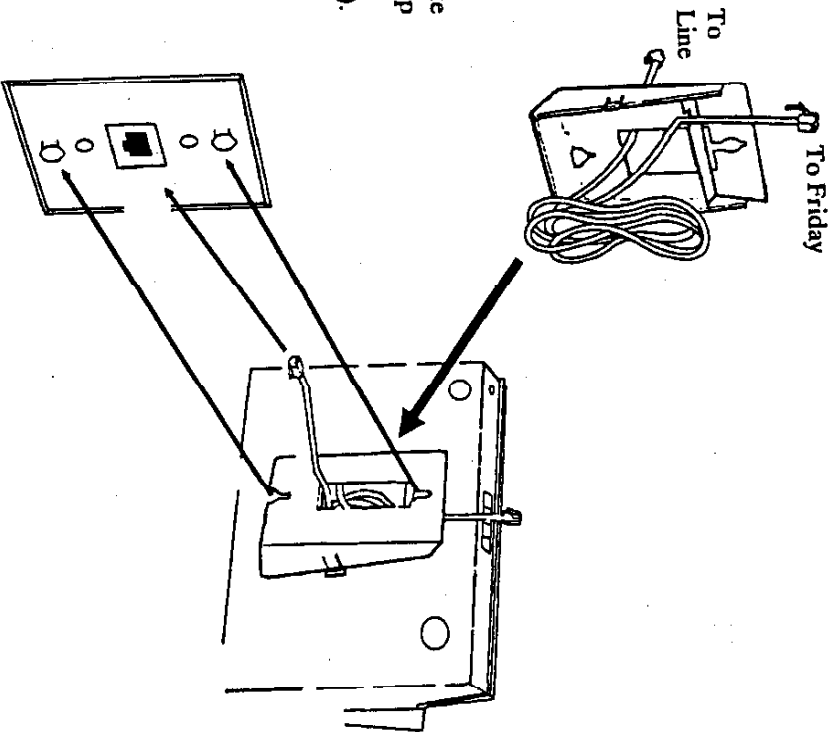

Installation

- If you want to install music-on-hold, or a fax or PC modem, see page 15.
- Proceed to the next page to connect the AC adaptor.
- If you do not have a telephone outlet wall plate, you can still mount Friday to the wall using the keyhole slots in the bracket. Use 2 screws, vertically placed, 4" apart, with the heads protruding approximately 3/16" from the wall. Align the bracket keyholes with the screws and pull down to secure.

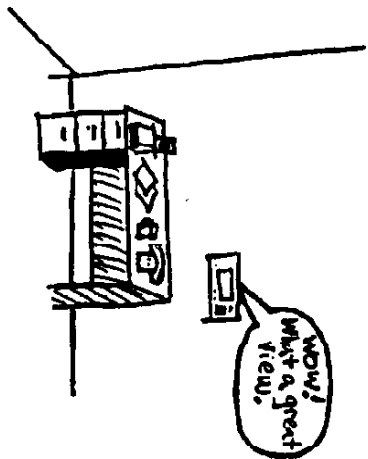

Installation

11. Connecting the AC Adapter

- Plug the output cord of the AC adapter into the jack on Friday marked Power.

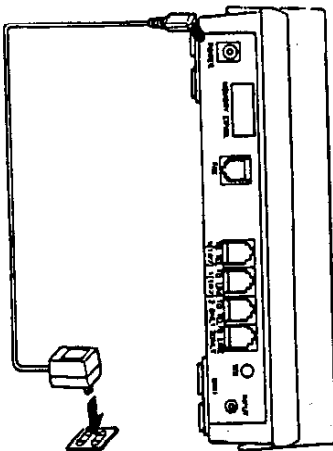

- Plug the AC adapter into an electrical wall outlet not controlled by a wall switch. Once power is applied, Friday's display will light up as shown below:

- The clock display in the right hand corner will then count backwards until the self-diagnostic test is complete (the unit will count down from 14 to 0 if no memory module is installed and 14 to 0 twice if a memory expansion module is installed). When the self-diagnostic test is complete, you will see the following display (if either of these fails to occur see In Case of Difficulty section of this manual).

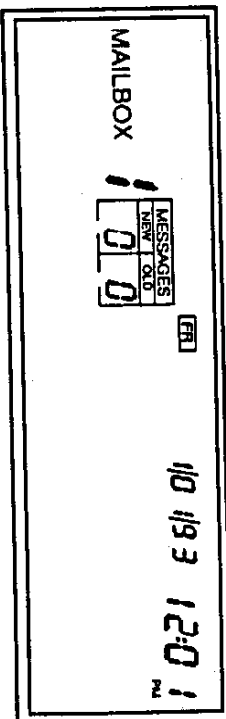

- You are now ready to proceed to the next page, Setting Up Friday.

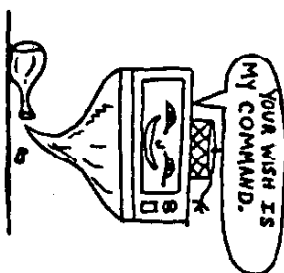
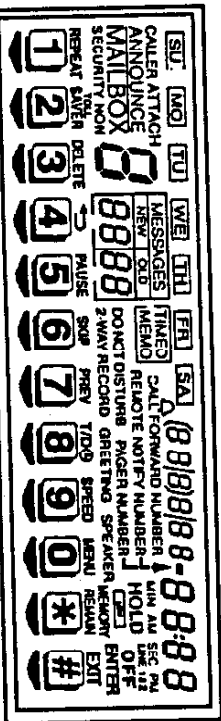

Setting Up Friday

12. Initial Settings

Friday interacts with you using sophisticated digital voice prompting. This prompting, along with visual displays on the LCD panel, let you customize your Friday to your exacting needs. As you examine Friday, you will notice that there are a series of functions printed on the front panel, each corresponding to a pushbutton. If you flip this panel down you will reveal additional functions for the pushbuttons. This means that the same button can perform two functions depending upon whether the lid is up or down.

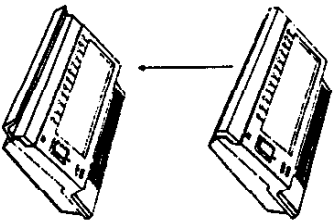

For example, when the lid is up and you press the button marked GREETING/ANNOUNCE, this function is enacted. But when the lid is down and you press same button, the TIME/DAY feature is activated.

Most of the time, you won't be using the functions under the lid because these are mostly used for initial settings. Also, once you practice using functions when the lid is up or down, you will see how simple the unit is to use.

Before you use Friday you should perform the following functions (Section numbers are shown in parenthesis). These functions are covered on the next few pages.

- Set Number of Rings (12.1)
- Set Time & Date (12.2)
- Adjust Volume (12.3)
- Check Calling Party Control Switch (12.4)
- Record Main Greeting (13)
- Setup Mailboxes (14)

In addition, you may wish to set the maximum message time (Section 24) if you want to give your callers more than the default time of 1 minute to leave a message.

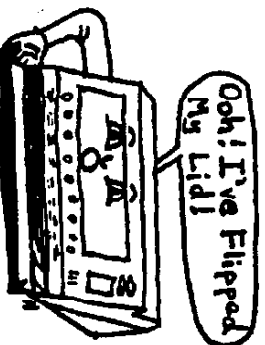

Setting Up Friday

12.1. Set the Number of Rings Desired

Friday is set to answer in 3 rings when it is shipped from the factory. You can set Friday to answer in 3, 4, or 5 rings, or for Toll Saver. In Toll Saver mode, Friday will ring four times before answering if there are no new messages. If Friday has a new message, it will answer after two rings. This means that if you call-in for your messages and Friday rings three times, you can hang up the phone before the fourth ring and incur no charge for the call.

If you are going to connect a fax machine, Friday should be set to answer in 3 rings (see Section 9.1). See also the Advanced Feature section for the Do Not Disturb feature which provides first ring pick up.

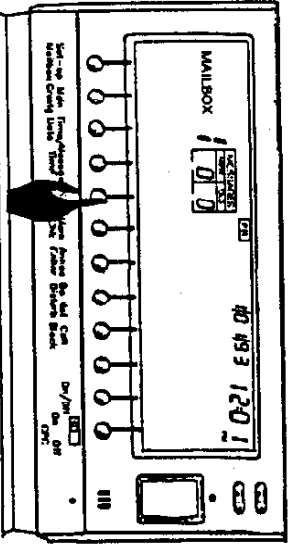

When you press the RINGS button, Friday says: "Rings" and you will see:

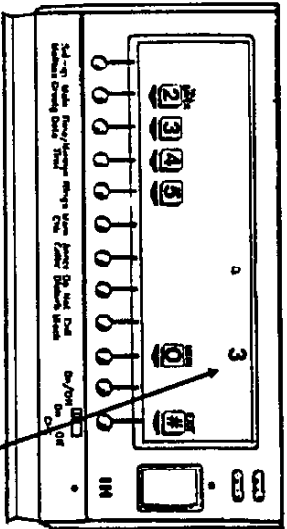

The default ring number will appear on the display. You will hear: "For Toll Save press 2, for 3 rings, press 3, for 4 rings, press 4, for 5 rings, press 5, to repeat the menu press 0, to exit from menu press #."

Each number will flash in succession during the prompt, however, you can press any button at any time to make a selection. To make your selection, press any of the buttons under the display icons [2] [3] [4] [5] [0] or [#]. Friday will confirm your selection and return to its normal display.

Note: Since the Toll Saver function indicates every new message on the system, this may mean in some instances that you have no new messages in your mailbox while others may have new messages in their mailboxes.

REMEMBER that you always have the option of repeating the menu by pressing 0 or exiting from the menu by pressing #.

Setting Up Friday

12.2. Set the Time and Date

To set the time and date flip the lid down and press the third button from the left marked TIME/DATE.

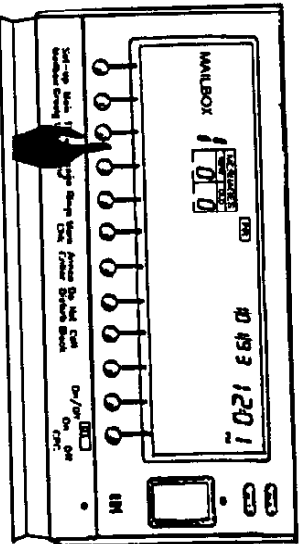

Then simply follow the voice and visual prompts.

You will hear: "To enter the time, press 1. To enter the date, press 2. To repeat the menu press 0. To exit from menu press #."

■ If you press [1] to Enter Time:

We will demonstrate this function by entering 2:36 PM as a sample time.

You will hear: "Enter hour and then press #."

You will see:

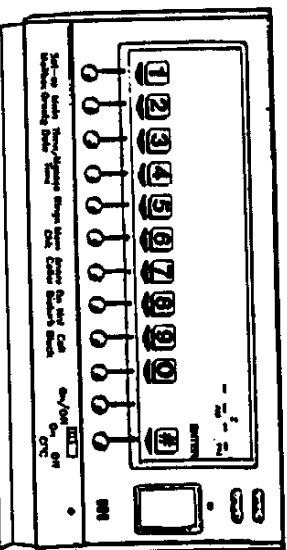

Enter the correct hour. Press the buttons below [2] and [#].

You will hear: "Enter minutes and then press #."

Enter the correct minutes. Press the buttons below the [3] and [6] and then [#].

Friday's display and voice prompting will then ask you to select AM or PM. In our example, you would select PM by pressing the button below the [2].

REMEMBER that you always have the option of repeating the menu by pressing 0 or exiting from the menu by pressing #.

Setting Up Friday

Friday will then tell you the time and you will see it on the display clock. You will be asked to save the time and be given the opportunity to change an incorrect entry. You will hear: "To change the time, press 1. To save, press 2."

If the time is correct, you should press the button below [2] in order to save it.

Once saved, Friday repeats the original Time/Date menu.

You will hear: "To enter the time, press 1. To enter the date, press 2. To repeat the menu press 0. To exit from menu press #." At this point you can proceed to set the date or exit from the menu by pressing the button below [#].

■ If you press [2] to Enter The Date:

Friday will prompt you to enter the month, date, and year (Friday will automatically calculate the day of the week). The process is similar to entering the time.

12.3. Set the Speaker Volume

You can increase or decrease the volume level of Friday's speaker. To change the volume, simply press the arrow buttons above and below the area marked **VOLUME**.

The volume increases or decreases with each press of the button. To increase the volume press the up arrow, to decrease the volume press the down arrow.

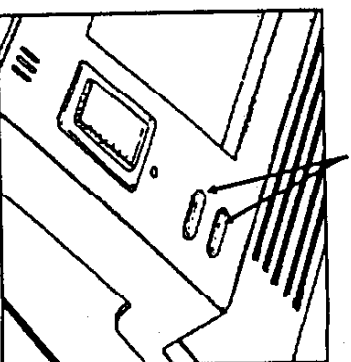

12.4. Check the CPC Switch (Calling Party Control)

The CPC switch determines how Friday processes an incoming call. The unit is shipped with this switch in the ON position, and this is the correct position for most applications. You should check to be sure the switch is in the ON position. The only time you may want to place the switch in the OFF position is if you find that callers' messages are cut off prematurely as a result of certain phone company services (such as call waiting).

Setting Up Friday

13. Main Greeting

After you have set Friday's clock and the number of rings (see important note on this page), you are ready to record your Main Greeting. The purpose of the Main Greeting is to greet callers and to offer them options of where to route their call.

Depending upon which mailboxes you have activated, you will want to offer the caller these selections in the Main Greeting.

An example of a Main Greeting where every mailbox is in use might be: *Hello, you have reached ABC Company. To leave a message for Dave, press 1; for Amy, press 2; for Pete, press 3; for Lisa, press 4. To hear our mailing address, press 5. To hear our office hours, press 6. To get directions, press 7. To send a fax press 8.* Sample Mailbox Greetings/Announcements for the above Main Greeting message are illustrated below. (See Section 16.)

Box No.	Owner	Mailbox Greeting/Announcement
1	Dave	"Hi, this is Dave. Please leave a message after the tone."
2	Amy	"Hi, this is Amy. Please leave a message after the tone."
3	Pete	"Hi, this is Pete..."
4	Lisa	"Hi, this is Lisa..."
5	Address	"Our mailing address is ..."
6	Hours	"Our office hours are from 9 to 5."
7	Directions	"To get to our office, take Route 17..."
8	Fax	none required

Important Note: You must activate Mailbox 8 to receive faxes (see Section 9.1 and 14). To use the autofax detection, you must program Friday to answer in three rings. (see Section 12.1.)

Using this greeting as an example, we will work you through setting up this greeting and the accompanying mailboxes. It is important that you understand that Friday is specifically designed to meet your individual needs. This means that you have complete control over the number of mailboxes activated (mailbox 1 is always on), the Main Greeting, and the Mailbox Greetings/Announcements for each mailbox that you activate.

Note: You may want to leave as part of your Main Greeting a message to callers that they can press the 0 key at any time to return to and repeat the Main Greeting. This allows callers to repeat the Main Greeting if they didn't catch all the options. It also lets callers leave messages in multiple mailboxes, hear multiple announcements or end the call by sending a fax.

Before you record your Main Greeting, use the chart and example on the next page to write out your message.

Setting Up Friday

Main Greeting Scripting Chart

Use this chart to create your own Main Greeting.

Step 1. Determine the owner of each voice mailbox (1 - 4). This can be one individual or a group/department.

Mailbox 1 Owner Dave
Mailbox 2 Owner Amy
Mailbox 3 Owner Pete
Mailbox 4 Owner Lisa

Step 2. If you are going to use announcement mailboxes, write the name of each here:

Mailbox 5 Name Mailing Address
Mailbox 6 Name Office Hours
Mailbox 7 Name Directions to Office
Mailbox 8 Name FAX/PC Modem

Step 3. Write your Main Greeting here:

"Hello, you have reached ABC Company. To leave a message for Dave, press 1; for Amy, press 2; for Pete, press 3; for Lisa, press 4. To hear our mailing address, press 5. To hear our office hours, press 6. To get directions, press 7. To send a fax press 8."

Step 1. Determine the owner of each voice mailbox (1 - 4). This can be one individual or a group/department.

Mailbox 1 Owner _____
Mailbox 2 Owner _____
Mailbox 3 Owner _____
Mailbox 4 Owner _____

Step 2. If you are going to use announcement mailboxes, write the name of each here:

Mailbox 5 Name _____
Mailbox 6 Name _____
Mailbox 7 Name _____
Mailbox 8 Name FAX/PC Modem

Step 3. Write your Main Greeting here:

Setting Up Friday

To use the Main Greeting function, flip down the lid and press the second button from the left marked MAIN GREETING.

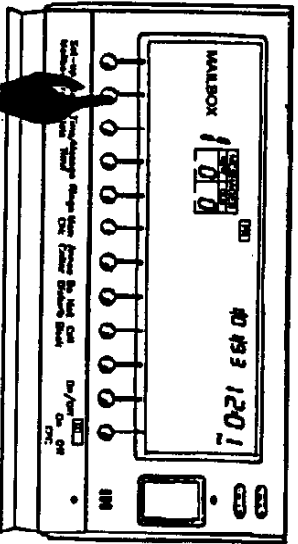

You will hear Friday say: "Main Greeting. To play Main Greeting press 1. To attach message to the Main Greeting press 2. To record Main Greeting press 7. To repeat the menu, press 0. To exit from the menu, press #."

Each function is described below:

Note: With the two line system, you are given the option of playing and recording a different Main Greeting for each of the two lines, or you can record one Main Greeting to be played for both lines. To program multiple greetings for a one-line unit, see Section 32, District Ring.

Friday User's Guide

13.1. To Play Main Greeting, Press 1

If you wish to play your Main Greeting, press the button below the flashing [1].

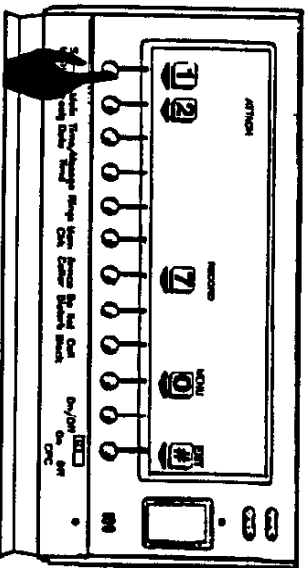

If no Main Greeting is recorded you will hear the factory recorded greeting: "No one is available to take your call."

13.2. To Attach a Message, Press 2

The Attach Message function lets you record and attach a message at the end of the Main Greeting. Usually, you will want to attach a message which you intend to delete after a few days. An example of an attach message is "Sorry, the office is closed today due to the national holiday."

Setting Up Friday

If you press the button below the flashing [2] you will hear: "Attach Message. To record Attach Message, press 7. To repeat the menu, press 0. To exit from menu, press #."

Friday will prompt you to select lines (if you have a 2-line unit) and then to begin recording at the tone. Once you press the button below [#], Friday will give you the opportunity to hear, delete or rerecord the Attach Message.

Simply select your choice and follow the voice and visual prompts (to remove an Attach Message, go to this menu and choose delete).

13.3. To Record Main Greeting, Press 7

The first step in recording your Main Greeting is to determine how many users there will be on the system, how many announcements you want, and if you will be attaching a PC or fax machine. To create your Main Greeting, use the chart on page 24.

To record the Main Greeting, press the button below the [7], and follow Friday's voice prompts.



Note: Friday has a high quality microphone that is able to pick up background noise rather easily due to its high sensitivity. Whenever you are recording using the microphone, you should be in a quiet location and speak clearly in a normal voice approximately 8 - 10 inches from the microphone.

14. Setting Up A Mailbox

Friday comes equipped with 4 voice mailboxes and 3 announcement boxes. The eighth mailbox manages the fax/PC port. In order for the mailbox to function (be able to receive messages from callers or state an announcement), the mailbox must be activated.

Follow the instructions below to activate or deactivate a mailbox and then proceed with the instruction in Section 15, Select Mailbox, to program mailbox functions.

Note: Mailbox one is always activated.

14.1. To Activate A Mailbox

To begin the process of setting up a mailbox(s) flip down the lid and press the first button from the left marked SETUP MAILBOX.

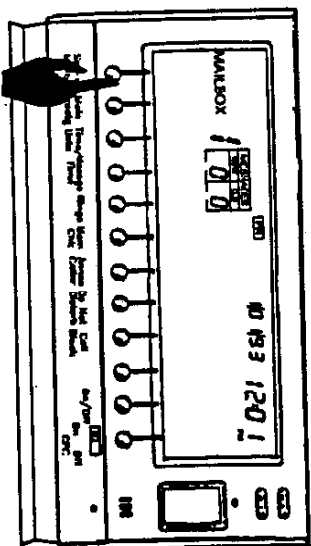

Friday User's Guide

Setting Up Friday

You will hear: "Select mailbox. For mailbox 1, press 1. For mailbox 2, press 2. For mailbox 3, press 3. For mailbox 4, press 4. For announcement box 5, press 5. For announcement box 6, press 6. For announcement box 7, press 7. For box 8, press 8. To repeat the menu press 0. To exit from menu, press #."

Select the mailbox that you wish to activate by pressing the button below the corresponding displayed number.

For example, if you want to activate mailbox 3, press the button below the [3] on the LCD screen.

You will then hear: "Mailbox 3 is off. To turn on mailbox 3 press 1. To repeat the menu, press 0. To exit from menu, press #."

If you press the button below the [1], you will hear: "Mailbox 3 is on."

Once the mailbox is activated, you can proceed to Section 15, Select Mailbox, to program mailbox functions such as recording a Mailbox Greeting (for mailboxes 1, 2, 3, and 4) or an announcement (mailboxes 5, 6, and 7.)

Hint: To see which mailboxes are active, make sure the lid is in the closed position and press the button marked SELECT MAILBOX. You will hear Friday say: "Select mailbox," and you will hear a list of all active mailboxes. Though this is not the main purpose of the SELECT MAILBOX function, it is a quick way to check which mailboxes are active. When you have finished checking, press the button below the [#] to exit from the menu.

14.2. To Deactivate A Mailbox

To deactivate a mailbox, press the same SETUP MAILBOX button as described above. You will then be given the menu of all mailboxes. Select the one you would like to deactivate, for instance mailbox 3.

You will hear: "Mailbox 3 is on. To turn off mailbox 3 press 2."

If you press the button below the [2], you will hear: "Mailbox 3 is off."

The LCD screen will return to its original display, with mailbox 1 and the time and date.

Note: Deactivating a mailbox erases the Mailbox Greeting/Announcement as well as all messages in that mailbox including any timed memos. If you deactivate a mailbox be sure to remove reference to the mailbox from the Main Greeting.

Working With Friday

15. Select Mailbox

The Select Mailbox button is used when you want to retrieve your messages locally from Friday or when you want to program or alter functions applying to a mailbox.

To access a particular mailbox, press the first button from the left marked SELECT MAILBOX.

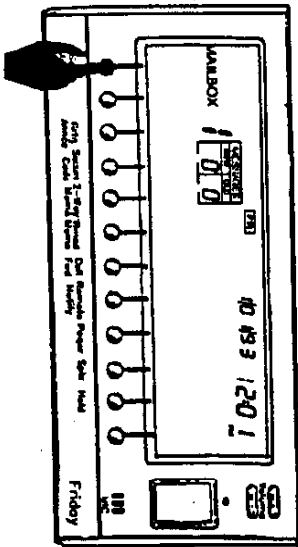

You will hear: "Select mailbox."

You are then prompted to select from all of the currently activated mailboxes. Select the desired mailbox, for example: mailbox 4.

You will hear: "Mailbox 4. Select function."

At this point you may select any of the available functions that you would like to apply to that mailbox (refer to the Mailbox Function Reference Chart.)

Mailbox Function Reference Chart

Feature	Entire System	Mailbox 1 - 4	Announce Box 5 - 7	Delta Box 8
Number of rings	X			
Time & date	X			
Time/day stamp		X		
Volume	X (speaker only)			
CPC	X			
Main greeting	X			
Set up mailbox		X	X	X
Select mailbox		X	X	X
Greeting/announce		X	X	X
Security code		X	X	X
2-way memo		X		
Timed memo		X		
Call forward		X		
Pager notify		X		
Remote notify		X		
Call block		X		
Max. message time	X			
Announce caller		X		
Do not disturb	X			
Memory check	X			
Retrieve message		X		
Speaker	X			
Hold	X			
On/off	X			
Distinct ring	X	(one line unit only)		

Friday User's Guide

Working With Friday

16. Mailbox Greeting/Announcement

The Mailbox Greeting/Announce function works very similarly to the Main Greeting function just described. The basic idea is the same: both allow you to record a personalized greeting for callers. The difference is that the Main Greeting is the first thing callers hear when Friday answers the call. The Mailbox Greeting/Announcement is what they hear once they have made a specific mailbox selection by pressing a button on their phone.

Remember: you must select a specific mailbox or announcement box before you can activate the Greeting/Announce function. The mailbox appearing on the display is the selected mailbox.

To activate the Mailbox Greeting/Announce function, select a mailbox and then press the third button from the left marked GREETING/ANNOUNCE.

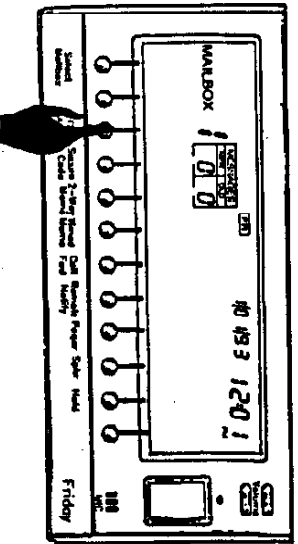

Friday User's Guide

Friday will give you the opportunity to play the current greeting or to record a new greeting. Simply follow the voice prompts and press the appropriate buttons.

■ An Example of a Mailbox Greeting

You can record a specific greeting or announcement for each Mailbox. If you do not record a mailbox greeting, Friday uses a default greeting that says: *"Please leave your message after the tone."*

Let's say that you want to record a new greeting for mailbox 2. You would first select mailbox 2 using the SELECT MAILBOX function and then press GREETING/ANNOUNCE.

You will hear: *"Greeting for mailbox 2. To play greeting, press 1. To record greeting, press 7. To repeat the menu, press 0. To exit from menu, press #."*

If you press the button below [7], you will hear: *"After the tone, record your greeting and then press #."*

After the tone you would record: *"Hello, this is Amy. I can't get to the phone, but leave your name and number after the tone and I'll get back to you."* You would then press the button below the [#].

After you press [#], you are offered the complete menu again, giving you opportunity to play the message, rerecord it, or exit by pressing [#].

Working With Friday

Note: You may choose to tell callers that they can return to the Main Greeting if they press 0 after they are finished with a mailbox and want to move to a different mailbox. Pressing 0 will return them to the start of the Main Greeting. An example building on the above would be, "Hello, this is Amy. I can't get to the phone, but leave your name and number and I'll get back to you. After you are finished, you can press 0 for more options."

An Example for an Announcement

The process of playing and recording an announcement (for mailboxes 5, 6, and 7), is identical to recording a Mailbox Greeting. The only difference is that the announcement is used solely to impart information to callers such as a business address or office hours.

An example: "Our office hours are from 8:30 to 5 pm, Monday through Friday."

After hearing the announcement, the caller is returned to the Main Greeting.

17. Security Codes

Security codes are provided for remote access to mailboxes 1 - 7. You must always enter the security code whenever you call in remotely to retrieve your messages or perform remote programming functions (see Sections 28 and 29). The security code does not interfere with a callers ability to leave a message, hear an announcement or send a fax.

You can also set up a security code to prevent local access to your messages or other mailbox functions. For mailboxes 1 through 4, the local security code ensures that only you can retrieve your messages or change call forward number, pager number, and remote notify number.

You have the freedom to turn the local security code protection on or off at will. You may also choose to implement them for some, none, or all 4 voice mailboxes. Once a code is entered, you can change the code.

Remember: Security codes are always required when you call in remotely to retrieve your messages. Turning a security code on or off only affects your ability to retrieve messages or change mailbox functions locally.

Working With Friday

To program a security code for your mailbox, you must first select your mailbox. Then press the fourth button from the left marked **SECURITY CODE**.

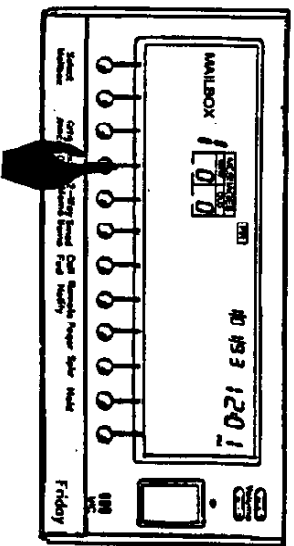

You will hear: "Security code. To turn security code on, press 1. To enter new security number, press 3. To repeat the menu, press 0. To exit from menu, press #."

Follow the voice and visual prompts.

After you have activated the security protection, you will need to enter your security code whenever you:

- Retrieve your messages
- Change your Mailbox Greeting
- Change your security code
- Record a timed memo
- Enter a call forward number
- Enter a pager or remote notify number

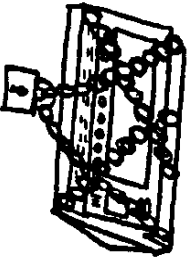

Hint: You may want to write down your four digit code and keep it in a safe place.

Note: The default code for each mailbox is the four repeated digits of that numbered box. For example, the default code for mailbox three is "3333". Whenever you do not have your own programmed security code, this default number will be your access code for remote programming and message retrieval.

To turn security code off, you must first select the mailbox and then press **SECURITY CODE**. Friday will ask for the current security number. Enter the number by pressing the appropriate buttons. If you enter the wrong number, Friday will say "Repeat. Enter security number." If you enter the wrong number again, you will be returned to the operating display (if you are calling remotely, and you enter an incorrect number twice, Friday will disconnect the line). Once you enter the correct number, Friday will prompt you to turn the security code off, to enter a new security number, to repeat the menu, or to exit from menu.

Note: If you forget your security code, you must reset Friday to the factory code by unplugging the power cord and removing the battery.

Working With Friday

18. How to Leave Messages for Others

Creating a memo makes it possible to leave a message in any of the activated message mailboxes.

To leave a memo first select a mailbox and then press the fifth button to the left marked 2-WAY/MEMO.

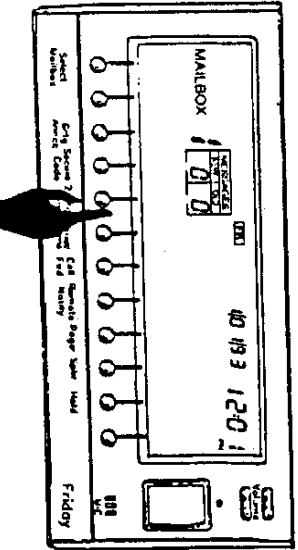

Once you press the button, the LCD screen will display the word MEMO, and you will hear: "Memo. Select mailbox."

The unit will offer through both voice and visual prompting the choice of leaving a memo in any of the four voice mail boxes (choice is only for those boxes which are active).

Select the mailbox (1, 2, 3, or 4). Friday will then say: "After the tone, record message and then press #."

Record your message and, to avoid having your message cut short, pause for 2 seconds after you finish speaking before pressing [#].

19. Timed Memo

The timed memo function is a useful and easy way to remind yourself of activities such as pending appointments. You can record up to 3 timed memos specifying the time and date to place the message in a mailbox. At the programmed time and date, Friday will sound a beep tone over the speaker and leave the message in your mailbox. To listen to the memo, simply select your mailbox and press the MESSAGES button.

To activate this function first select a mailbox and then press the sixth button from the left marked TIMED MEMO.

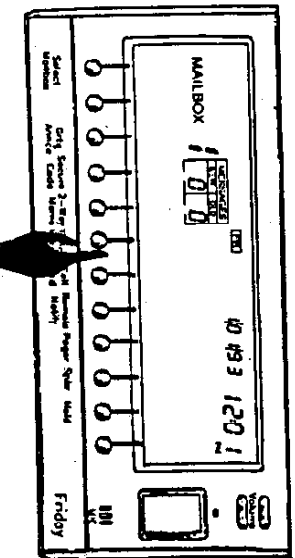

In the following example, we will assume that you are currently in Mailbox 2 and wish to leave a timed memo for Mailbox 2.

You will hear: "Timed memo for mailbox 2. After the tone, record message and then press #." After you record your message, pause for 2 seconds and then press the button below the [#]. Friday says: "Enter time and date to forward message to mailbox 2."

Simply follow the voice and display prompts.

Advanced Features

Advanced Features

Friday has a variety of advanced features beyond allowing you to call in and retrieve your messages. Friday can call forward to any telephone number you select, forward calls to your pager service, and even notify you if a caller leaves an urgent message. See the following sections on Call Forward (Section 20), Pager Notification (Section 21) and Remote Urgent Message Notification (Section 22) for details on how to operate these features.

Note: You must have a two phone lines for the 2-line model, or 3-Way Calling from the phone company for the 1-line model in order for Call Forward and Pager Notify to work.

Note: When Call Forward is activated, a caller will not be offered Pager Notify or Remote Notify options, even if these options are activated. If just Pager Notify and Remote Notify are activated, the caller will be offered both options.

20. Call Forward

The Call Forward function will automatically forward calls in real time to any preprogrammed telephone number that you choose. The number can have up to twenty digits (though only the last 14 are displayed). See the following section on Special Numbers for information on programming telephone numbers.

Friday User's Guide

To activate the Call Forward function, select a mailbox and then press the seventh button from the left marked **CALL FORWARD**.

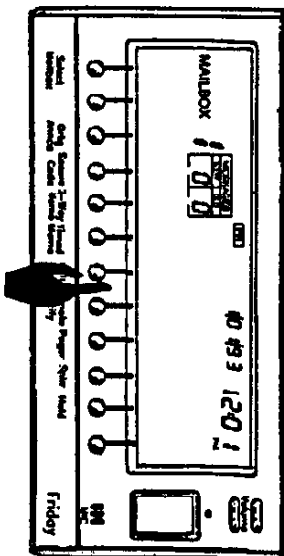

You will hear: "Enter new call forward for mailbox X (selected mailbox number). To enter new call forward number, press 3. To repeat the menu, press 0. To exit from menu, press #." Press the button below [3] then follow the voice prompts to enter a Call Forward number.

When a caller selects a mailbox that has Call Forwarding activated, a choice is given to leave a message (by pressing 0) or to forward the call. Friday then calls out on the second line (for 2-line model) or uses 3-Way Calling to dial the Call Forward number (1-line model). For the 1-line unit, a prompt plays to the call forward number: "Call Forward for mailbox X. Press #." When the party presses [#], Friday connects the caller to the Call Forward number.

In the event of a busy signal, or if there is no answer, the caller is automatically routed to your mailbox to leave a message.

Advanced Features

Special Numbers

When entering a number for Call Forward or Pager Notify, Friday can place a pause, star (*), or pound (#) in the phone number string. This gives Friday the ability to dial a number where it is necessary to wait several seconds for a dial tone (e.g. 9 [pause] 201-934-8500) or for a PBX to answer and offer a menu before continuing to dial the number (e.g. 201-934-8500 [pause] ext. 245), or when necessary to add symbols after an extension number, pager identification number, etc. (e.g. 201-934-8500 [pause] ext. 245#).

To add a pause, each press of [*] [5] during programming will add a four (4) second pause to the number dialed.

An example would be [1] [2] [0] [1] [9] [3] [1] [4] [8] [5] [0] [0] [*] [5] [*] [5] [1] [1] [1]. If you were to enter this number, Friday would confirm the selection with the following prompt: "New call forward number 1-2-0-1-9-3-4-8-5-0-0-pause-pause-1-1-1 is on."

Note: For these situations, it may be worthwhile to dial the number and measure the pause time to ensure successful Call Forwarding.

21. Pager Notification

The Pager Notification function is similar to Call Forwarding and allows callers to be routed to your pager service where they can request to have you paged. (See Quick Tips & Clever Tricks to use Remote Notify to page you.) Friday prompts callers: "To leave a message, press 2. To call forward to pager, press 3."

To activate this function, select a mailbox and then press the ninth button from the left marked, PAGER. All of the same number choices are possible here as described under Call Forward and Special Numbers.

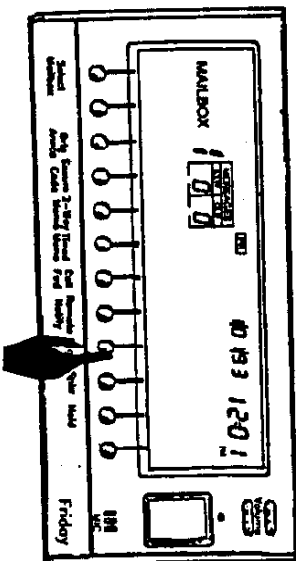

Note: You can give instructions in your greeting to tell callers how to interact with your paging service. Since Friday dials your paging service, you don't have to worry about callers paging you when you don't want them to - when Pager Notification is off, callers can't page you.

Advanced Features

22. Remote Urgent Message Notification

Remote Notification lets you program a number where Friday can reach you to notify you that there is an urgent message waiting for you in your mailbox.

When Remote Notify is on, callers are asked if their message is urgent. If they indicate that it is, Friday will call you at the number you have programmed and play the prompt: "Remote Notify for mailbox X Press *."

Note: When Friday calls you, there will be a 6-8 second period of silence. You are then prompted to press [*] and your 4-digit security code. You can then retrieve the message by pressing [1].

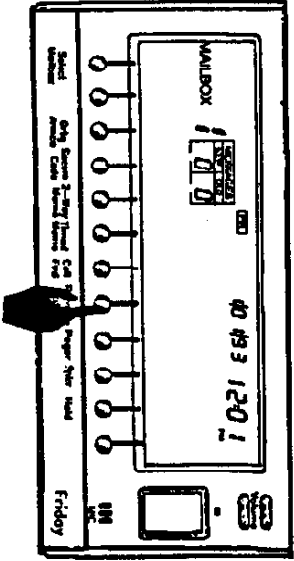

To activate Remote Notify, select a mailbox and then press the eighth button from the left marked REMOTE NOTIFY. The prompts follow the same format as described for Call Forward.

Friday User's Guide

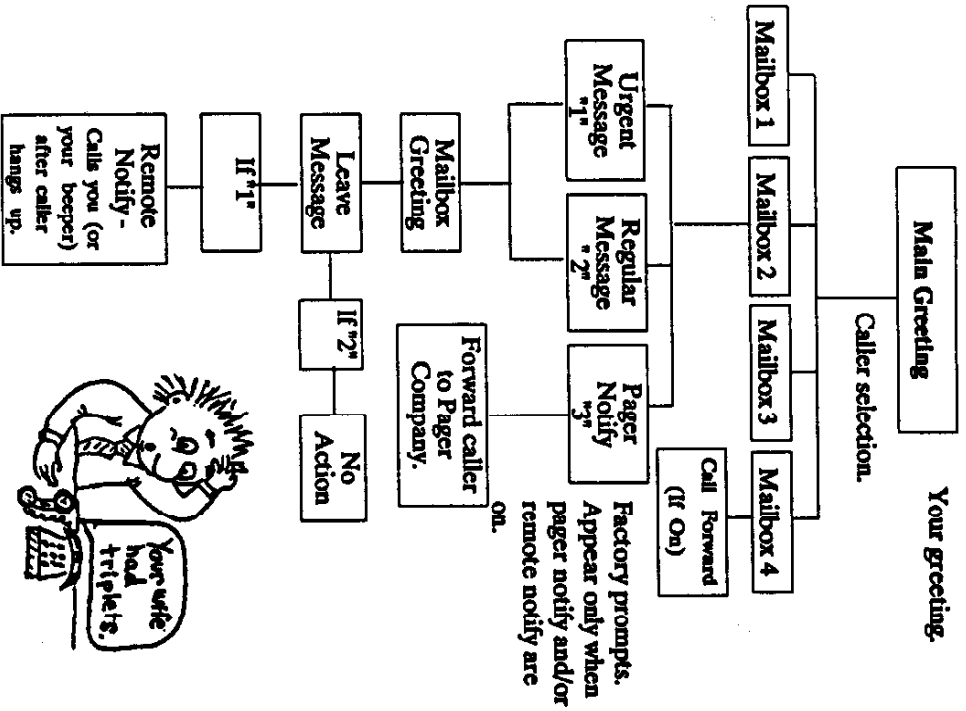

Advanced Features

23. Call Block

Toll Fraud has become a big problem in the United States, especially in large companies.

The purpose of Call Block is to prevent toll fraud by blocking all Call Forward, Remote Notify, and Pager Notify attempts which begin with prefix numbers that you designate. Friday can store up to 4 prefixes of up to 4 digits (e.g. 011, 1, 1201, 1900, etc.) To activate the Call Block function flip the lid down and press the ninth button from the left marked CALL BLOCK.

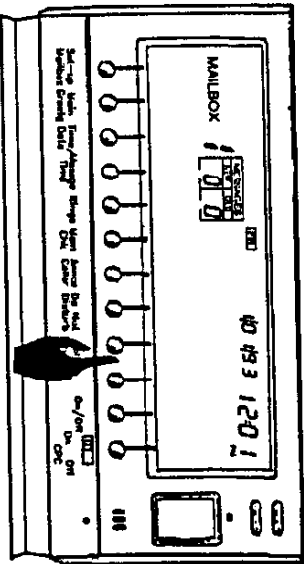

Simply follow the voice prompts to complete this function.

24. Maximum Message Time

In order to control the amount of memory used for callers' messages, you can set the maximum time for callers to record their messages. You can set recording time of up to 1, 2, or 3 minutes (1 minute is the default).

This feature may be particularly useful if you will not be retrieving your messages for some time or if you receive large numbers of messages.

If the caller begins to exceed the maximum time, the caller hears: *"Maximum message time is X minutes. Your message has been saved."* Friday will then disconnect the call.

To set message length flip the lid down and press the fourth button from the left marked MSG TIME.

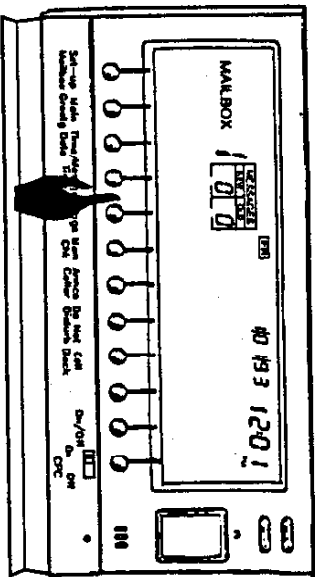

Note: The maximum message time applies to all 4 voice mailboxes.

Advanced Features

25. Announce Caller

The Announce Caller function can be used to screen your calls. **IF OFF** – Flip the lid down and press the seventh button from the left marked **ANNOUNCE CALLER** to turn on.

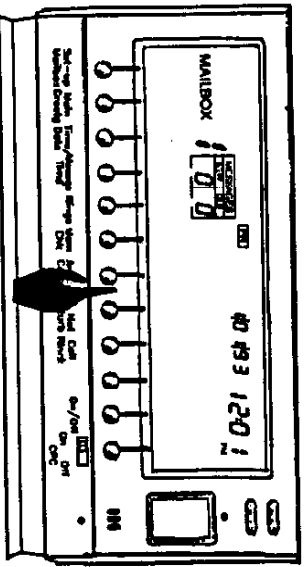

When the Announce Caller function is activated, callers are prompted to state their name after they have selected a mailbox. As the caller speaks his or her name, the unit will play the name over the speaker. If you pick up the phone, you will be instantly connected to the caller. But, if you choose not to pick up the phone within 5 seconds, the caller will be prompted to leave a message.

26. Do Not Disturb

The Do Not Disturb function allows you to work in peace without hearing the constant ringing of the telephone or hearing messages left. The Do Not Disturb function answers the phone after 1 full ring and can be turned on and off by the same button.

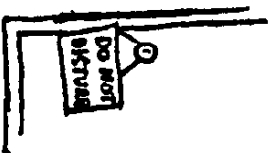

Flip down the lid and press the eighth button from the left marked **DO NOT DISTURB** to turn on or off.

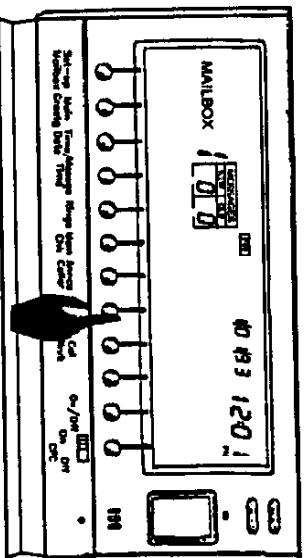

Note: Do Not Disturb overrides the Announce Caller feature.

Advanced Features

27. Memory Check

Friday's digital memory is not partitioned among mailboxes; rather, it is a pooled resource. This means that the allocation of digital memory is dependent upon where memory use is called for.

You can use the memory check function to see if you are in danger of running out of memory. To activate, flip the lid down and press the sixth button from the left marked **MEMORY CHECK**.

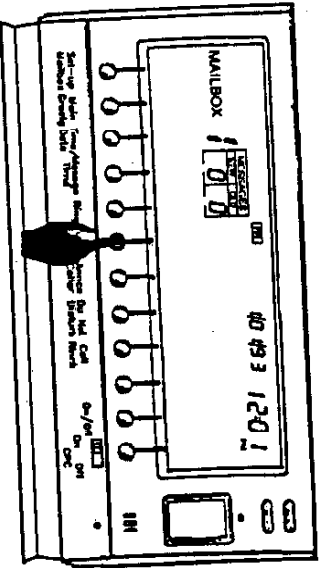

Note: The unit automatically notifies you with a Low Memory Icon when the memory is down to 2 minutes or less. When the memory reaches zero, a "Memory is full" prompt plays when you attempt to record a message or pressing.

28. Retrieving Your Messages

The red LED above the **MESSAGES** button will light when there are any new messages in the system.

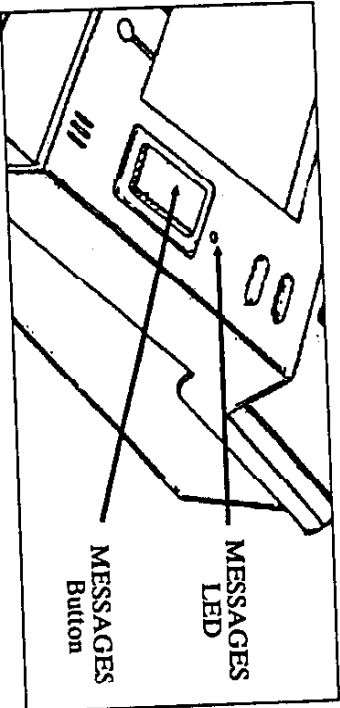

Follow the instructions on the next page to retrieve your messages locally or remotely.

Important Note: Friday can store up to 95 caller messages. All messages will be erased if this maximum number is exceeded.

Note: If you retrieve a message and hear telephone ringing, this is the result of a failed Call Forward attempt where the caller hangs up before the call forward is completed.

Advanced Features

28.1 To Retrieve Messages Locally

To retrieve your messages locally, make sure that the function lid is fully closed. Then select your mailbox (if not already displayed) by pressing the first button from the left marked **SELECT MAILBOX**.

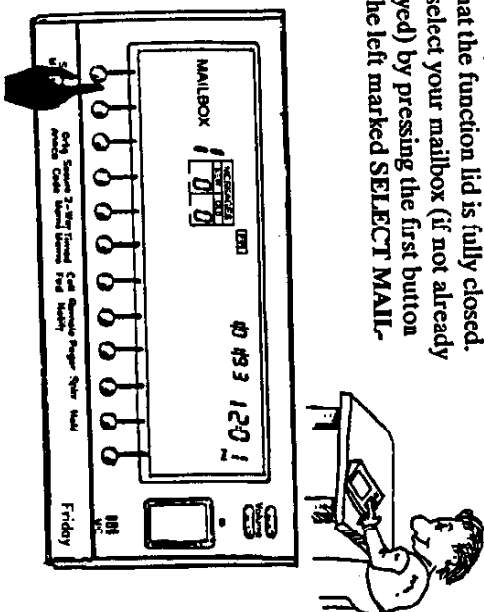

Once your mailbox is selected, the new/old message count will be displayed on the LCD screen. To retrieve either new or old messages press the large button on the right marked **MES-SAGES**.

The unit will tell you how many new messages and how many old messages you have, or, if no old messages are stored, immediately play the first new message.

After listening to each message, a variety of choices on how to treat each message is offered. A chart of these Message Options is on the next page.

28.2. To Retrieve Messages Remotely

When calling in for your messages or to program the unit, listen to the Main Greeting, and select your mailbox. During your Mailbox greeting, press the [*] button on the telephone. Friday will prompt you to enter your security code. If you enter an incorrect code twice, Friday will disconnect the call.

After you enter the correct code, you will hear: "For your messages, press 1." (Also, you will hear a variety of options after this.) After pressing [1], you will hear the same prompts as if you had retrieved the messages locally.

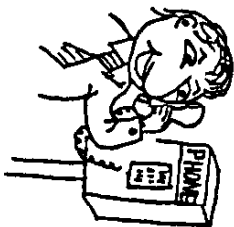

Advanced Features

Message Options

To repeat message, press 1.*

The repeat function lets you to hear the message again.

To save message to your mailbox, press 2.*

This function allows you to save the message that you just listened to in your mailbox. Note: Saving moves the message into the old message area.

To delete, press 3.*

Using this function deletes the message. Note: It is suggested that you delete all unwanted messages so that digital memory can be freed up.

To repeat from first message, press 4.*

This allows you to repeat your messages starting with the first message.

To pause, press 5.*

Pressing the pause button immediately halts the message being listened to. To resume listening exactly where you left off, simply press the pause button again. Note: the unit will pause indefinitely until you press the pause button again.

To skip forward, press 6.*

Selecting this function allows you to skip to the next message. Note: if this function is selected, the message skipped remains a new message.

To skip back one message, press 7.*

This allows you to skip back to the previous message. Note: if the previous message was deleted, the unit will automatically skip back to the message before the deleted message.

To play time-day for message, press 8.*

Selecting this function allows you to hear the day of the week, and time of day that the message was received. To turn this function on press 8, to turn it off, press 8 again. Note: When the function is activated, the clock symbol above the 8 will be lit. Note: turning it on activates the function for all messages until the time-day is turned off.

To play message with different speed, press 9.*

There are two options when choosing the speed function (in addition to normal speed of course): Pressing the speed button once, plays the message more slowly. If you press the button again, you return to normal speed. Pressing the speed button three times allows you to hear the message at a faster speed than normal. Pressing the button again allows you to hear the message at regular speed. Therefore the play pattern is NORMAL - SLOW - NORMAL - FAST.

To save to different mailbox, press *.*

There may be times when you receive an important message that you want others to hear. Pressing [*] after hearing the message allows you to transfer that message to any of the other 3 (if active) message mailboxes. Note: Messages can NOT be copied, only transferred.

Advanced Features

29. Programming Friday Remotely

You can program Friday's mailboxes from a remote telephone. Simply call in, listen to the Main Greeting and select the desired mailbox. During the Mailbox Greeting, press [*]. Friday will prompt you to enter your security code. After you enter the correct code, you will hear a list of options. Simply choose the option you wish to program and follow the voice prompts.



OWNER

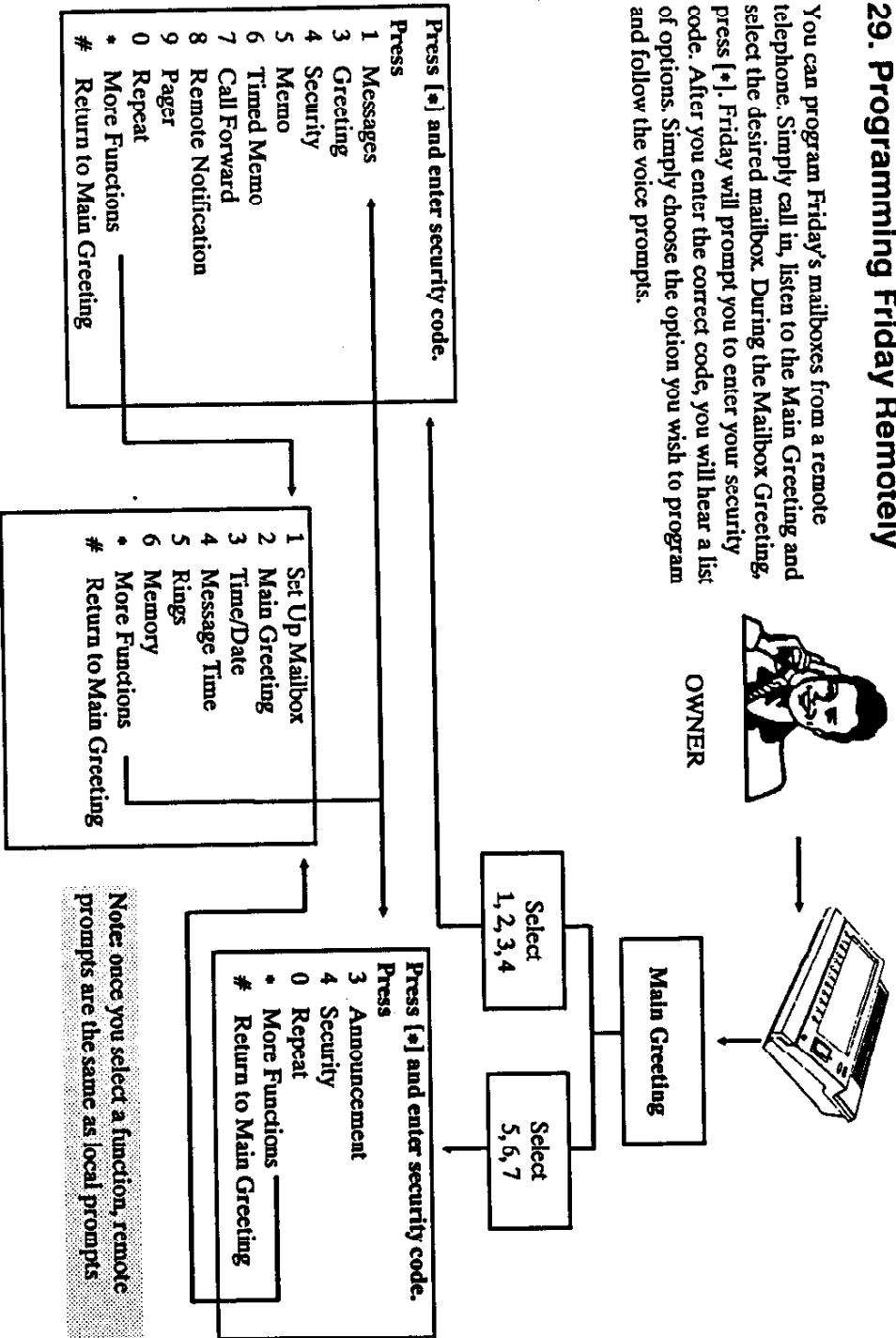

Note: once you select a function, remote prompts are the same as local prompts

Advanced Features

30. Friday from the Callers Perspective

Unlike voice mail, Friday does not frustrate callers. Your caller will not hear needless menus and multi-layered questions to get the service they deserve.

When Friday answers, the caller hears either a factory recorded Main Greeting ("No one is available to take your call.") or your custom-recorded Main Greeting. If Mailbox 8 is activated, Friday answers with a prompt that requests callers to "please press 0," followed by a 10-second pause. During the pause, Friday will respond to the CNG (tone of a fax machine and automatically route a fax call to your fax machine. If the caller presses [0], the Main Greeting will play.

One example of a Main Greeting may be: "Hello. You have reached ABC. To leave a message for Mike, press 1. To leave a message for Jane, press 2, for James press 3. To hear our office hours press 5. To send a fax press 8."

The caller simply selects the desired mailbox by pressing the appropriate key on the telephone (rotary phone users will be routed to mailbox 1 to leave a message). Once in a voice mailbox, the caller hears either the factory recorded Mailbox Greeting ("Please leave your message after the tone.") or personalized greeting such as "Hi, this is Mike. I can't answer your call at this time, but leave your name and number and I'll get back to you."

A caller may return to the Main Greeting by pressing [0] after finishing with a mailbox. An example building on the above would be, "Hello, this is Mike. I can't get to the phone, but leave your name and number and I'll get back to you. After you are finished, you can press 0 to return to the Main Greeting."

Call Forward/Pager Notify Operation

1-line unit. When a caller selects a mailbox that is set for Call Forward, the caller hears: "To record a message, press 0. To forward your call, press 1." If [1] is pressed, the caller is prompted: "Do not hang up for 30 seconds," and is placed on hold. Friday then dials the Call Forward number and prompts the answering party: "Call Forward for Mailbox X. Press *." When the answering party presses the [*] key, the caller is connected. If there is no answer, the caller is prompted to leave a message.

2-line unit. When the caller selects a mailbox that is set for Call Forward, the caller hears: "Press 0 to leave a message or your call is being forwarded." Friday then uses the second line to forward the call. If the second line is unavailable, or if the call forward number is busy, the caller is prompted to leave a message.

If Pager Notify is activated, the caller is prompted: "Press 2 to leave a message or press 3 to call forward to pager." If [3] is pressed, the call is forwarded to the pager service. In the 1-line unit, the caller is prompted: "Do not hang up for 15 seconds," and is placed on hold. Friday then dials the Pager Notify number and, if the number is not busy, connects the caller to the ringing line.

If Remote Notify is activated, the caller is prompted to press 1 if the message is urgent or 2 if not. If [1] is pressed, Friday calls the Remote Notify number after the caller hangs up and informs the owner of an urgent message.

Advanced Features

32. Set Distinct Ring

Note: This feature is only available on the 1-LINE system.

Your local telephone company may offer a service called Distinctive Ring, Ident-A-Ring, or some other name. This service allows you to have multiple numbers on the same line so that you can publish separate numbers for your home phone, business phone, fax or modem and have them all ring the same phone. Each number would have a different ring for identification purposes. Friday's Distinct Ring function automatically routes Distinct Ring calls to a different Main Greeting if you do not answer the phone.

The Friday routes calls by detecting the ring pattern.

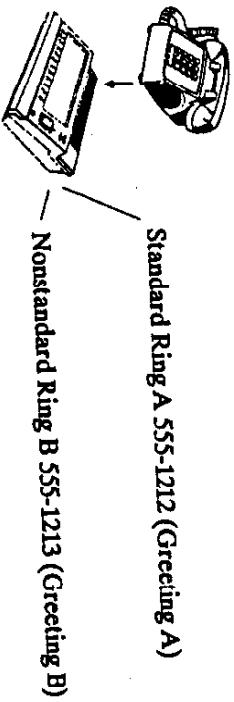

Thus, you can separate home calls from business calls by designing certain mailboxes for business calls on one Main Greeting and other mailboxes for personal calls on a second Main Greeting.

44

For example, let's assume Lee operates a business out of the home and wants to separate personal calls from business calls.

RING A: BUSINESS GREETING-

"Hello, you've reached ABC Company. For Lee, press 1. For Pat, press 2. For our mailing address, press 5. To send a fax, press 8."

RING B: HOME GREETING-

"Hello, you've reached the Smith residence. For Lee, press 1. For Gene, press 3. To leave a message for the kids, press 4. For the kids' summer camp address, press 6."

To activate Distinct Ring,

Flip down the lid and press the ninth button from the left marked **DISTINCT RING** and follow the prompts.

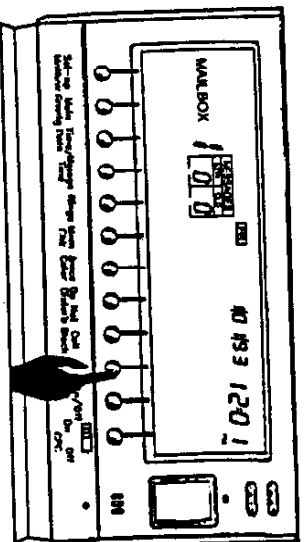

Friday User's Guide

Options While On The Phone

36. How to Record a Phone Conversation:

With the 2 Way/Memo function, you also have the ability to record a phone conversation into a specific message mailbox

WARNING: IT IS ILLEGAL TO RECORD A CONVERSATION WITHOUT FIRST OBTAINING THE RECORDEES PERMISSION.

Press the button marked 2-WAY/MEMO (signifying 2-way record) during a phone conversation (under [5]).

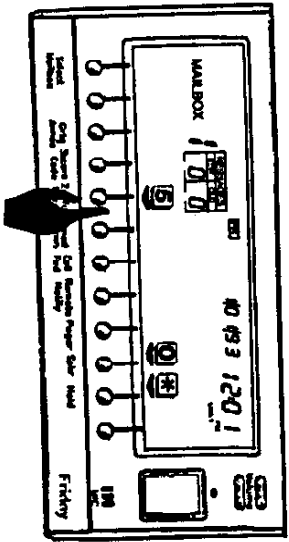

Note: In the 2-line unit, Friday can not take calls from the other line while the 2-WAY/MEMO function is in use. Also, only one line at a time can use the function.

Note: When this function is enacted during a phone conversation, there will be no voice prompting. You will see displayed on the LCD screen exactly the same prompts as are shown when the function is enacted for the purpose of leaving a memo in a mailbox. The choice of mailbox is only from those which are active.

Note: If no selection is made, the unit returns to the mailbox 1 display without recording.

Once you make your mailbox selection, the LCD display shows the mailbox selected into which the message will be recorded. Pressing the button below [#] ends the recording.

37. How to Return a Caller to the Main Greeting

When talking to callers, you may want to return them to the Main Greeting so that they can select a different mailbox to leave a message, send a fax, etc.

To do this, simply press the MESSAGES key during your conversation. Your caller is automatically returned to the Main Greeting. You may hang up the phone.

In Case of Difficulty

If your Friday does not work properly, try the following suggestions before seeking assistance.

■ **Display Screen Remains Blank.**

- Check the AC connections on the back of the unit and the electrical outlet.
- Move the AC adapter to another wall outlet.
- Check the connection into the unit.

■ **No Messages Received**

- Check Main Greeting to see if your mailbox is offered.
- Check all line cord connections at both the wall jack, the telephone, and the FRIDAY.

■ **No Calls Forwarded**

- For a one-line unit, check to make sure that you are receiving three-way calling service from your local phone company. For a two-line unit, make sure both lines are plugged in.
- Check Call Block numbers.

■ **No Voice Prompting Can Be Heard.**

- Make sure the VOLUME switch is turned up high enough so as to be audible.

■ **If You Press a Function Button and Nothing Happens**

- Make certain that the lid is either fully up or down.

■ **Messages Cut Off**

- Check CPC switch.

Quick Tips & Clever Tricks

As you become comfortable with operating the Friday, you will start to discover that there are many "hidden" features in the system. These are features that may not be readily accessible from the listed functions on the panels, but are useful for tailoring Friday to your very specific needs. The following are just some of these features:

Speed Preempting. Once you become familiar with selecting options from the voice and visual prompts, you may no longer wish to listen to the choices to make your selection. You can jump over voice and visual prompts by pressing the button that you want once the menu has begun to be offered.

Remotely Receiving Timed Memos. You can use Friday to receive timed memos remotely. For example, let's assume that you are going to be out of the office all day travelling with your cellular phone, and you want to remind yourself of an important appointment that you have at a particular time. Simply record a Timed Memo in your mailbox and set your mailbox in the Remote Notify mode. Now when the memo comes due, it will be played, dropped into your mailbox, and Friday will call you on your cellular phone to notify you of this important memo.

Alarm Clock. Friday can be used as a traditional alarm clock both locally and remotely.

Locally. To use Friday as an alarm clock, simply record a timed memo to be played back at a predetermined time. You will hear a beep when the message comes due.

Remotely. Similar to the method used in the above section on remotely receiving timed memos, a timed memo can function as an alarm clock preprogrammed to wake you at a certain time at some remote location.

Hidden Mailboxes. You can choose to activate mailboxes without notifying callers of their existence in the Main Greeting. For instance, a message mailbox may be reserved for only those whom you tell. This way only those who know to select the mailbox to leave a message can - examples may be a box only for family members to leave messages on or a box only for your employees to leave messages for you. Announcement boxes can also be activated without notifying callers of their existence.

One example of a use for this is to relay private outbound messages for employees (ie. pricing information) without anyone else knowing it exists. Note: a security code that only employees know can also be placed on the voice mailbox to prevent tampering.

Using Multiple Message Mailboxes to Serve an Individual's Needs. - One person can use multiple mailboxes for multiple purposes. Extra message mailboxes (boxes 1-4) can be used to further tailor Friday to meet your needs. For instance, mailbox one may be used as a regular message receiving mailbox, while mailbox 2 may be used to forward calls to you at a preprogrammed Call Forward number. Thus, your main greeting may state, "Hello. You've reached ABC Company. To leave a message for Amy, press 1. To have your call forwarded to Amy, press 2..."

Quick Tips & Clever Tricks

Using Friday as a Work Group Voice Mail Station - Friday can be used in an office environment for a work group station of up to four people (if each requires his or her own mailbox.) If fewer than three message mailboxes are being utilized, the fourth can be programmed to connect callers to an operator (either in the office or perhaps to a main office). Simply program the extra mailbox to the required Call Forward number and include this option in your Main Greeting (i.e., "...to reach the operator, press 4.") Note: Since callers have the option of being rerouted to the Main Greeting, they can leave a message and then go back and select the operator.

Mixing the sequence of mailboxes in your greeting to serve your customers. Example: "Hello, if you want information on upcoming concerts, press 5. For prices, press 6. Otherwise, press 1 or stay on the line to leave a message. Thank you."

Using Remote Notify to page you. Instead of having Friday call you with an urgent message, you can program the unit to dial your pager number, and then pause and enter an access code or number to prompt you to call your office. When you are paged, you will see that the call came from Friday. Simply call in and retrieve your message remotely

BOGEN[®]
COMMUNICATIONS, INC.
50 Spring Street, Ramsey, NJ 07446